

İçindekiler • Table of Contents

Laparoskopi
Laparoscopy

Pediyatrik Laparoskopiy
Pediatric Laparoscopy

Torakoskopiy
Thoracoscopy

Jinekoloji
Gynaecology

Uroloji
Urology

Artroskopiy
Arthroscopy

Ekipmanlar
Equipment

Sinüskopi - Laminektomi
Sinuscopy - Laminectomy

ve / and

K.B.B Aletleri
ENT Instruments

Laparoskopi

Laparoscopy



| İçindekiler - Laparoskopi | Sayfa |
|--|--------------|
| Derin Dikiş Deep Suture | 3 - 4 |
| Safra Kesesi Çıkarma Spekulumu Spekulum for Gallbladder extraction | 5 |
| Trokar Kılıfları-Trokarlar Trocar sleeves, trocars | 6 - 8 |
| Redüktör Kolları,Dilatasyon Setleri , LAP-Aksesuarları Reducer sleeves, Dilatation Sets, LAP-Accessories | 9 |
| Otoklavlanabilir Laparoskoplar Autoclavable Laparoscopes | 10 |
| Fiber Optik Kabloları-Halojen Free Bağlantı Kabloları Fibre light cables, HF connection cables | 11 |
| Kanca Elektrotlar Hook Electrodes | 12-13 |
| Monopolar Elektrotlar Monopolar Electrodes | 14-15 |
| Vakum-Sulama Tabanca Kolu, Enjeksiyon İğnesi ,Konektörler Suction-Irrigation Pistol handle, Injection needle, Connectors | 16-17 |
| Laparoskopi Aksesuarları, Kolesistektomi Accessories for Laparoscopy / Cholecystectomy | 17 |
| Dönebilen ve Sökülebilen Araç-Gereçler Rotating and detachable Instruments | 18-33 |
| Endo-Kanca Sistemi,Karaciğer Kaldıraç Endo-Hook-System, Liver elevator | 34-36 |
| Kesi ve Kavrama Uygulayıcıları ve Dikiş Kaydırma Araçları Clip-Applier and knot slider instruments | 37 |
| Bakım ve Temizleme Care and Cleaning | 38 |
| Sökülebilir Forsepsler (İki Kutuplu - Bipolar) Detachable Forceps (bipolar) | 39-41 |

Deep Suture Deep Suture

Açık karın cerrahisinde iyi sonuçlar almak için, geleneksel teknikler geliştirdik. Modern video-endoskopik uygulama teknolojileri ve uygun araç-gereçlerle ameliyat erişim travmaları büyük ölçüde azaltıldı. Küçük delikler , karın kesitlerinin yerini aldı. Minimal yaygın cerrahinin avantajları, sonuca gitmek için sağladığı kolaylıklardır.

Endoser, yeni geliştirdiği bir dizi araç ile laparoskopik çalışma tekniklerine çağdaş katkılar sunuyor. Endoskopik erişimlerde, derin karın zarı ve bağ dokular teknik sorunlar beraberinde getirir. Bu durumlarda olası komplikasyonları önlemek arzu edilir (Fıtık, Birleşme gibi).

Endoser olarak "Deep Suture" (Derin Dikiş) ile size basit , hızlı ve kesin çözümler sunuyoruz.

Bu cihaz ,endoskopik çalışma kanallarına sorunsuz eklenebilen, 12'mm çapında , çubuk şeklinde bir dikiş aygıtıdır. Yara kanalı , dış kılavuz çubuğuna sıkıca yatırılır, dikiş iplikli yanal iğneler döner kontrol vidasının tepesi ile genişletilir. Cihaz üzerindeki güçlü gerginlik sayesinde, iğneler karın zarı ve bağ dokuya nüfus eder. Bu şekilde eklenen iplik alınır ve el ile bağlanır. Böylece, siz olağan şekilde doku üzerindeki iplik gerginliğini belirlemiş olursunuz.

The good results of open abdominal surgery can hardly be improved upon using conventional techniques. Through the application of modern video-endoscopic technology and appropriate instruments, however, the trauma of operative access can be substantially reduced. Small punctures replace abdominal sections. The advantages of minimal invasive surgery are the result.

With a number of newly developed instruments Endoser would like to make an up-to-date contribution to laparoscopic operating techniques.

The deep peritoneum and fascia closure of an endoscopic access involves technical problems, but is desirable in order to avoid any complications (hernia, conrescence).

With Endoser DEEP SUTURE we offer you a simple, quick and sure solution. This instrument is a rod-shaped sewing device with a diameter of 12 mm which can be inserted through the endoscopic working channels without any problem. The wound channel lies tightly against the outer guide rod. The lateral needles with thread/suture are extended by turning the top control screw. By means of strong tension on the instrument, the needles penetrate the peritoneum and fascia. The thread inserted in this way is taken up and tied by hand. Thus you determine the thread tension on the tissue in the usual manner.



Deep Suture
Derin Dikiş



Anahtar: Endoser Derin Dikiş

- ① Kontrol Vidası
- ② Kol
- ③ İğne tutucu
- ④ Özel İğnesi

Teknik deęişimler saklıdır.

Key: Endoser Deep Suture

- ① Control screw
- ② Handle
- ③ Lateral needle holder
- ④ Special needle

Technical alternation reserved.

| | |
|----------|---|
| 24-00001 | Endoser Derin Dikiş İğnesi 3 ve 5 cm iğne uyumlu |
| 24-00008 | 3cm 'lik delikli iğne (12 Adet) |
| 24-00009 | 5 cm'lik Delikli İğne (4 Adet) |
| 24-00010 | Özel Yağ (P-102,100ml) Tüm Endoser Aletleri için |

| | |
|----------|---|
| 24-00001 | Endoser Deep Suture suitable for 3 cm and 5 cm needles |
| 24-00008 | 12 Spare needles 3 cm with eye |
| 24-00009 | 4 spare needles 5 cm with eye |
| 24-00010 | Special oil P-102, 100 ml for all Endoser instruments |

Safra Kesesi Çıkarma Spekulumu
Speculum for Gallbladder extraction

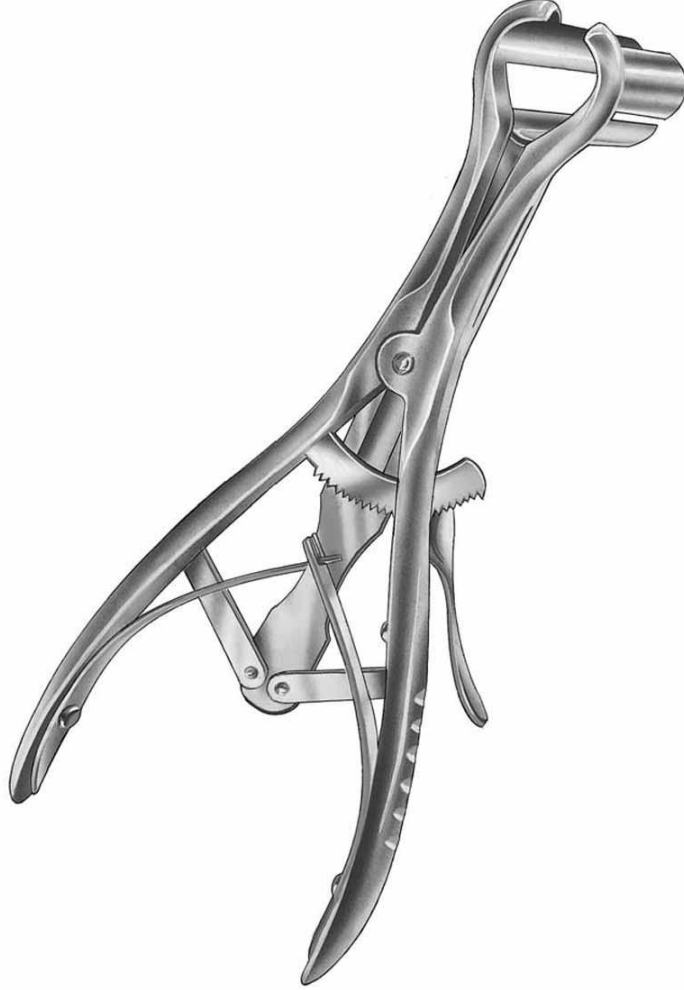

27-00037 **Safra Kesesi**
Çıkarma Spekulumu

27-00037

Speculum for
Gallbladder extraction

Supaplı Trokar Kılıfları

Trocar Sleeves with Trumpet valve

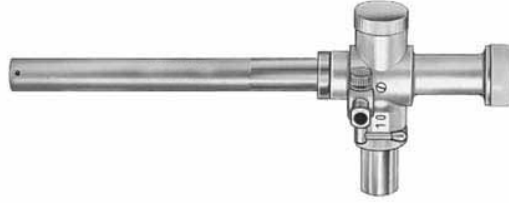

Supaplı Trokar Kılıfları ve muslukları

Trocar sleeve with trumpet valve and stopcock

| | |
|----------|-----------|
| 29-00505 | Ø 5,0 mm |
| 29-00506 | Ø 5,5 mm |
| 29-00510 | Ø 10,0 mm |
| 29-00509 | Ø 10,5 mm |
| 29-00511 | Ø 11,0 mm |
| 29-00512 | Ø 12,5 mm |

| | |
|----------|-----------|
| 29-00505 | Ø 5,0 mm |
| 29-00506 | Ø 5,5 mm |
| 29-00510 | Ø 10,0 mm |
| 29-00509 | Ø 10,5 mm |
| 29-00511 | Ø 11,0 mm |
| 29-00512 | Ø 12,5 mm |

Redüktörler PPSU

| | |
|----------|------------------|
| 29-00569 | Ø 10,0 - 5,5 mm |
| 29-00569 | Ø 11,0 - 5,5 mm |
| 29-00570 | Ø 12,5 - 10,0 mm |
| 29-00571 | Ø 12,5 - 5,5mm |



Reducer PPSU

| | |
|----------|------------------|
| 29-00569 | Ø 10,0 - 5,5 mm |
| 29-00569 | Ø 11,0 - 5,5 mm |
| 29-00570 | Ø 12,5 - 10,0 mm |
| 29-00571 | Ø 12,5 - 5,5 mm |

3 kenarlı ve sivri uçlu trokar

Metal ve plastik trokar kılıflarına uyumlu

Trocars with three-edged tip, suitable for metal- and plastic-trocar sleeves

| | |
|----------|-----------|
| 29-01505 | Ø 5,0 mm |
| 29-01506 | Ø 5,5 mm |
| 29-01510 | Ø 10,0 mm |
| 29-01509 | Ø 10,5 mm |
| 29-01511 | Ø 11,0 mm |
| 29-01513 | Ø 12,5 mm |

| | |
|----------|-----------|
| 29-01505 | Ø 5,0 mm |
| 29-01506 | Ø 5,5 mm |
| 29-01510 | Ø 10,0 mm |
| 29-01509 | Ø 10,5 mm |
| 29-01511 | Ø 11,0 mm |
| 29-01513 | Ø 12,5 mm |



Koni uçlu Trokar

Trocars with conical tip

| | |
|----------|-----------|
| 29-02505 | Ø 5,0 mm |
| 29-02506 | Ø 5,5 mm |
| 29-02510 | Ø 10,0 mm |
| 29-02509 | Ø 10,5 mm |
| 29-02511 | Ø 11,0 mm |
| 29-02513 | Ø 12,5 mm |

| | |
|----------|-----------|
| 29-02505 | Ø 5,0 mm |
| 29-02506 | Ø 5,5 mm |
| 29-02510 | Ø 10,0 mm |
| 29-02509 | Ø 10,5 mm |
| 29-02511 | Ø 11,0 mm |
| 29-02513 | Ø 12,5 mm |



Çok kullanımlı güvenli

Reusable safety trocars (3-edge grinding)

| | |
|----------|-----------|
| 29-01025 | Ø 5,0 mm |
| 29-01026 | Ø 5,5 mm |
| 29-01030 | Ø 10,0 mm |
| 29-01031 | Ø 11,0 mm |
| 29-01032 | Ø 12,5 mm |

| | |
|----------|-----------|
| 29-01025 | Ø 5,0 mm |
| 29-01026 | Ø 5,5 mm |
| 29-01030 | Ø 10,0 mm |
| 29-01031 | Ø 11,0 mm |
| 29-01032 | Ø 12,5 mm |

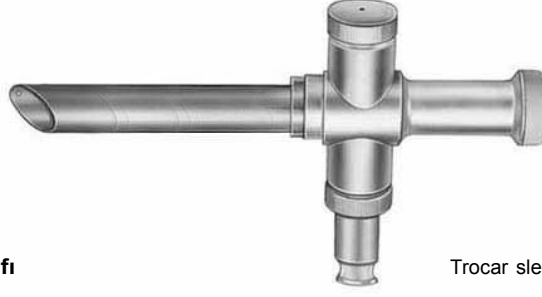
**Boru vanalı Trokar Kılıfı**

29-00515 Ø 15,0 mm
29-00520 Ø 20,0 mm

Trocar sleeve with trumpet valve

29-00515 Ø 15,0 mm
29-00520 Ø 20,0 mm

**3 Kenarlı,Sivri uçlu Trokar**

29-01515 Ø 15 mm
29-01520 Ø 20 mm

Trocar with three-edged tip

29-01515 Ø 15 mm
29-01520 Ø 20 mm

**Koni Uçlu Trokar**

29-02515 Ø 15 mm
29-02520 Ø 20 mm

Trocar with conical tip

29-02515 Ø 15 mm
29-02520 Ø 20 mm

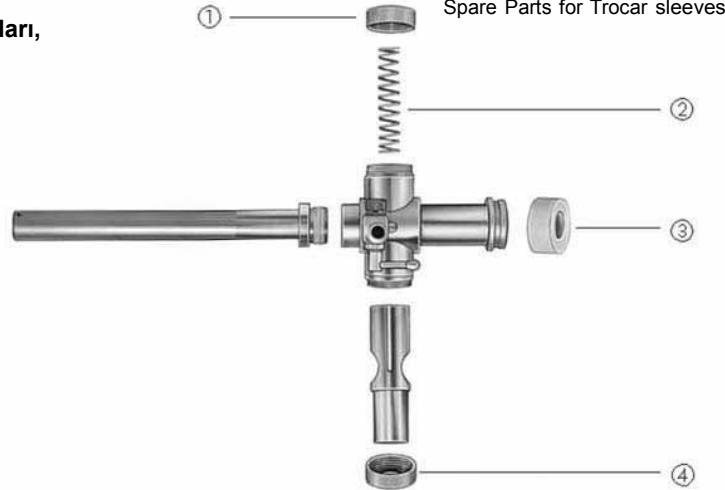
Trokar kılıfı yedek parçaları,

| Ø Trokar Çapı Trocar sizes | ① Kapalı Süpap KAPAGI Valve Cap,Closed | ② YAY Spring | ③ Sızdırmazlık tıkaçı, 10 ADET Sealing cap, 10 pieces | ④ Açık Süpap Kapağı Valve cap, open |
|----------------------------------|--|--------------------|---|---|
| 5,0 mm | 29-00635 | 29-00642 | 29-00650 | 29-00661 |
| 5,5 mm | 29-00635 | 29-00642 | 29-00650 | 29-00661 |
| 10,0 mm | 29-00636 | 29-00643 | 29-00653 | 29-00662 |
| 10,5 mm | 29-00636 | 29-00643 | 29-00653 | 29-00662 |
| 11,0 mm | 29-00636 | 29-00643 | 29-00653 | 29-00662 |
| 12,5 mm | 29-00637 | 29-00643 | 29-00656 | 29-00663 |
| 15,0 mm | 29-00638 | 29-00647 | 29-00657 | 29-00664 |
| 20,0 mm | 29-00640 | 29-00648 | 29-00659 | 29-00666 |

Otomatik Trokar Kılıfları

Automatic trocar sleeves



Musluklu Oto. Trokar Kılıfları

Automatic trocar sleeves with stopcock

| | |
|----------|-----------|
| 29-00535 | Ø 5,0 mm |
| 29-00536 | Ø 5,5 mm |
| 29-00540 | Ø 10,0 mm |
| 29-00541 | Ø 11,0 mm |
| 29-00542 | Ø 12,5 mm |

| | |
|----------|-----------|
| 29-00535 | Ø 5,0 mm |
| 29-00536 | Ø 5,5 mm |
| 29-00540 | Ø 10,0 mm |
| 29-00541 | Ø 11,0 mm |
| 29-00542 | Ø 12,5 mm |



Musluklu ve Manuel Kapaklı Trokar Kılıfları

Automatic trocar sleeves with stopcock and manual Trap Door

| | |
|----------|-----------|
| 29-00735 | Ø 5,0 mm |
| 29-00736 | Ø 5,5 mm |
| 29-00740 | Ø 10,0 mm |
| 29-00741 | Ø 11,0 mm |

| | |
|----------|-----------|
| 29-00735 | Ø 5,0 mm |
| 29-00736 | Ø 5,5 mm |
| 29-00740 | Ø 10,0 mm |
| 29-00741 | Ø 11,0 mm |



Kullanışlı Redüktör

Reducer „easy“

| | |
|----------|------------------|
| 29-00565 | Ø 10,0 - 5,5 mm |
| 29-00565 | Ø 11,0 - 5,5 mm |
| 29-00565 | Ø 12,5 - 5,5 mm |
| 29-00567 | Ø 12,5 - 10,0 mm |

| | |
|----------|------------------|
| 29-00565 | Ø 10,0 - 5,5 mm |
| 29-00565 | Ø 11,0 - 5,5 mm |
| 29-00565 | Ø 12,5 - 5,5 mm |
| 29-00567 | Ø 12,5 - 10,0 mm |

Trokar kılıfı yedek parçaları,

Spare Parts for Trocar sleeves



| Ø Trokar Çapı Trocar sizes | ① Conta Bileziği, 10 Adet Sealing ring, 10 pieces | ② Conta Bileziği, 10 Adet Sealing ring, 10 pieces | ③ Vida Kapağı Screw cap | ④ Sızdırmaz Tıkaç, 10 Adet Sealing cap, 10 pieces |
|-------------------------------|---|---|-------------------------------|---|
| 5,0 mm | 29-00670 | 29-00675 | 29-00678 | 29-00650 |
| 5,5 mm | 29-00670 | 29-00675 | 29-00678 | 29-00650 |
| 10,0 mm | 29-00671 | 29-00676 | 29-00679 | 29-00653 |
| 10,5 mm | 29-00671 | 29-00676 | 29-00679 | 29-00653 |
| 11,0 mm | 29-00671 | 29-00676 | 29-00679 | 29-00653 |
| 12,5 mm | 29-00671 | 29-00676 | 29-00679 | 29-00656 |

Redüktör Kılıfları, Dilatasyon Setleri , LAP-Aksesuarları

Reducer Sleeves, Dilatation Sets, LAP-Accessories



Trokar-Stop

| | |
|----------|-----------|
| 29-00090 | Ø 5,0 mm |
| 29-00091 | Ø 5,5 mm |
| 29-00092 | Ø 10,0 mm |
| 29-00093 | Ø 10,5 mm |
| 29-00094 | Ø 11,0 mm |
| 29-00095 | Ø 12,5 mm |

Trocar-Stop

| | |
|----------|-----------|
| 29-00090 | Ø 5,0 mm |
| 29-00091 | Ø 5,5 mm |
| 29-00092 | Ø 10,0 mm |
| 29-00093 | Ø 10,5 mm |
| 29-00094 | Ø 11,0 mm |
| 29-00095 | Ø 12,5 mm |



Redüktör Kılıfları

| | | | |
|----------|-----------|---|-----------|
| 29-00104 | Ø 10,0 mm | ■ | Ø 5,5 mm |
| 29-00104 | Ø 11,0 mm | ■ | Ø 5,5 mm |
| 29-00106 | Ø 12,5 mm | ■ | Ø 5,0 mm |
| 29-00108 | Ø 12,5 mm | ■ | Ø 10,0 mm |
| 29-00110 | Ø 15,0 mm | ■ | Ø 5,0 mm |
| 29-00113 | Ø 15,0 mm | ■ | Ø 10,0 mm |
| 29-00114 | Ø 15,0 mm | ■ | Ø 11,0 mm |
| 29-00116 | Ø 20,0 mm | ■ | Ø 5,0 mm |
| 29-00118 | Ø 20,0 mm | ■ | Ø 10,0 mm |
| 29-00120 | Ø 20,0 mm | ■ | Ø 11,0 mm |

Reducer sleeves

| | | | |
|----------|-----------|---|-----------|
| 29-00104 | Ø 10,0 mm | ■ | Ø 5,5 mm |
| 29-00104 | Ø 11,0 mm | ■ | Ø 5,5 mm |
| 29-00106 | Ø 12,5 mm | ■ | Ø 5,0 mm |
| 29-00108 | Ø 12,5 mm | ■ | Ø 10,0 mm |
| 29-00110 | Ø 15,0 mm | ■ | Ø 5,0 mm |
| 29-00113 | Ø 15,0 mm | ■ | Ø 10,0 mm |
| 29-00114 | Ø 15,0 mm | ■ | Ø 11,0 mm |
| 29-00116 | Ø 20,0 mm | ■ | Ø 5,0 mm |
| 29-00118 | Ø 20,0 mm | ■ | Ø 10,0 mm |
| 29-00120 | Ø 20,0 mm | ■ | Ø 11,0 mm |



Dilatasyon Setleri (Dilatasyon çubuğu+Kılıfı)

| | | | |
|----------|-----------|---|-----------|
| 29-00132 | Ø 5,0 mm | ■ | Ø 10,0 mm |
| 29-00140 | Ø 5,0 mm | ■ | Ø 15,0 mm |
| 29-00142 | Ø 5,0 mm | ■ | Ø 20,0 mm |
| 29-00144 | Ø 10,0 mm | ■ | Ø 15,0 mm |
| 29-00146 | Ø 10,0 mm | ■ | Ø 20,0 mm |
| 29-00148 | Ø 11,0 mm | ■ | Ø 15,0 mm |
| 29-00150 | Ø 11,0 mm | ■ | Ø 20,0 mm |

Dilatations sets, consisting of:
Dilatations rod and dilatation sleeve

| | | | |
|----------|-----------|---|-----------|
| 29-00132 | Ø 5,0 mm | ■ | Ø 10,0 mm |
| 29-00140 | Ø 5,0 mm | ■ | Ø 15,0 mm |
| 29-00142 | Ø 5,0 mm | ■ | Ø 20,0 mm |
| 29-00144 | Ø 10,0 mm | ■ | Ø 15,0 mm |
| 29-00146 | Ø 10,0 mm | ■ | Ø 20,0 mm |
| 29-00148 | Ø 11,0 mm | ■ | Ø 15,0 mm |
| 29-00150 | Ø 11,0 mm | ■ | Ø 20,0 mm |



Varis'e Göre Üfleme İğneleri

| | |
|----------|---------------|
| 29-00160 | 2.00 x 100 mm |
| 29-00162 | 2.00 x 120 mm |
| 29-00164 | 2.00 x 140 mm |
| 29-00165 | 2.00 x 150 mm |
| 29-00170 | 2.00 x 200 mm |

Insufflation's needle according to Veress

| | |
|----------|---------------|
| 29-00160 | 2.00 x 100 mm |
| 29-00162 | 2.00 x 120 mm |
| 29-00164 | 2.00 x 140 mm |
| 29-00165 | 2.00 x 150 mm |
| 29-00170 | 2.00 x 200 mm |

Dereceli
Palpasyon Mili

| | |
|----------|---------------|
| 29-03510 | 330 mm Ø 5 mm |
| 29-03511 | 450 mm Ø 5 mm |

Palpation probe graduated

| | |
|----------|---------------|
| 29-03510 | 330 mm Ø 5 mm |
| 29-03511 | 450 mm Ø 5 mm |



Otoklavlanabilir Laparoskoplar Autoclavable Laparoscopes

Bütün Teleskoplar, aşağıdaki markaların tümüne uyum için, 3 çeşit değişken kablo konektörleri ile donatılmışlardır.

All telescopes are equipped with a 3-way variable cable connector to connect the following systems:

ACM, WOLF, STORZ, OLYMPUS

ACM, WOLF, STORZ, OLYMPUS



Laparoskopi Optikleri, 2,3 Bar (134 °C) 'de Otoklavlanabilir

Optics for Laparoscopy
autoclavable at 2,3 bar (134°C)

| | |
|----------|--------------------------|
| 31-00010 | Ø 5 mm, görüş açısı 0° |
| 31-00020 | Ø 5 mm, görüş açısı 30° |
| 31-00030 | Ø 10 mm, görüş açısı 0° |
| 31-00040 | Ø 10 mm, görüş açısı 30° |
| 31-00050 | Ø 10 mm, görüş açısı 45° |

| | |
|----------|-------------------|
| 31-00010 | Ø 5 mm, view 0° |
| 31-00020 | Ø 5 mm, view 30° |
| 31-00030 | Ø 10 mm, view 0° |
| 31-00040 | Ø 10 mm, view 30° |
| 31-00050 | Ø 10 mm, view 45° |

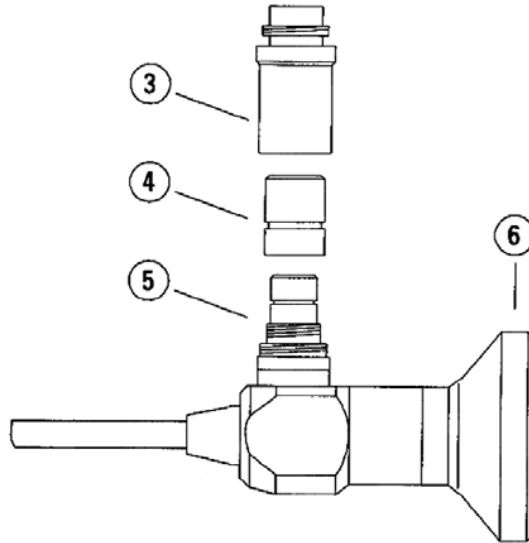

Optik Adaptörleri şeması,

Adapter for optics

- ③ Storz®/Olympus® - Adaptör
- ④ Wolf® - Adaptör
- ⑤ ACM® - konektör
- ⑥ Mercek

- ③ Storz®/Olympus® - adapter
- ④ Wolf® - adapter
- ⑤ ACM® - connector
- ⑥ Eyepiece



FİBER IŞIK KABLOLARI Otoklavlanabilir- 2,3bar (134°C)

Fibre Light cables, autoclavable at 2,3 bar (134°C)

| Ekipman Adaptörü Equipment adapter | Endoskop Adaptörü Endoscope adapter | Ø [mm] | Uzunluk 1800 mm Length 1800 mm | Uzunluk 2300 mm Length 2300 mm | Uzunluk 3000 mm Length 3000 mm |
|---------------------------------------|--|-----------|-----------------------------------|-----------------------------------|-----------------------------------|
| ENDOSER / Storz | ENDOSER / Storz | 4,8 | 31-00200 | 31-00201 | 31-00202 |
| ENDOSER / Storz | ENDOSER / Storz | 6,0 | 31-00205 | 31-00206 | 31-00207 |
| Winter / Ibe | ENDOSER / Storz | 4,8 | 31-00210 | 31-00211 | 31-00212 |
| Winter / Ibe | Winter / Ibe | 6,0 | 31-00215 | 31-00216 | 31-00217 |
| Wolf / HSW | Wolf / HSW | 4,8 | 31-00220 | 31-00221 | 31-00222 |
| Wolf / HSW | Wolf / HSW | 6,0 | 31-00225 | 31-00226 | 31-00227 |
| ACM / British | ACM / British | 4,8 | 31-00230 | 31-00231 | 31-00232 |
| ACM / British | ACM / British | 6,0 | 31-00235 | 31-00236 | 31-00237 |

Yüksek Performanslı Işık Kaynakları için,

Daha güçlü ışık kabloları / Otoklavlanabilir- 2,3bar (134°C)

High Power Light cables for Light Sources with high performance, autoclavable at 2,3 bar (134°C)

| Geräte-Adapter Equipment adapter | Endoskop-Adapter Endoscope adapter | Ø [mm] | Länge 1800 mm Length 1800 mm | Länge 2300 mm Length 2300 mm | Länge 3000 mm Length 3000 mm |
|-------------------------------------|---------------------------------------|-----------|---------------------------------|---------------------------------|---------------------------------|
| ENDOSER / Storz | ENDOSER/ Storz | 4,8 | 31-00500 | 31-00501 | 31-00502 |
| Winter / Ibe | ENDOSER / Storz | 4,8 | 31-00510 | 31-00511 | 31-00512 |
| Wolf / HSW | Wolf / HSW | 4,8 | 31-00520 | 31-00521 | 31-00522 |
| ACM / British | ACM / British | 4,8 | 31-00530 | 31-00531 | 31-00532 |

HF-Bağlantı Kablosu

HF connection cable



28-00000

HF-Bağlantı Kablosu, 3,5 m uzunluğunda, giriş-çıkışlı

28-00000

HF connection cable, plug-socket, length 3,5 m

**Kanca Uçlu Elektrotlar Ø 5 mm x 330 mm /
450 mm**

Hook-tip electrodes Ø 5 mm x 330 mm / 450 mm

Azami Ölçüde uca kadar izole edilmiş kanca uçlu elektrot, Hook-tip electrodes insulated on the front, to max. extent



**28-00100 Elektrot kolu, -araç kolunu istenilen
uzunlukta ayarlamak için kullanılır.-**

28-00100

Endoser handle
for individual length
adjustment of the instrument arm



28-00001 Künt , 330 mm Uzunluk

28-00001

blunt,
length 330 mm

28-00101 Künt , 450 mm Uzunluk

28-00101

blunt,
length 450 mm



28-00002 Elmas şekil 1 keskin, 330 mm

28-00002

diamond shaped cutting surface
length 330 mm

28-00102 Elmas şekil 1 keskin, 450mm

28-00102

diamond shaped cutting surface
length 450 mm



28-00003 Künt , L uçu 330mm

28-00003

blunt,
length 330 mm

28-00103 Künt , L uçu 450 mm

28-00103

blunt,
length 450 mm



28-00004 Elmas şekil 2 keskin ,330 mm

28-00004

diamond shaped cutting surface
length 330 mm

28-00104 Elmas şekil 2 keskin ,450 mm

28-00104

diamond shaped cutting surface
length 450 mm



28-00005 Elmas şekil 3 keskin ,330 mm

28-00005

diamond shaped cutting surface
length 330 mm

28-00105 Elmas şekil 3 keskin ,450 mm

28-00105

diamond shaped cutting surface
length 450 mm

**Kanca Uçlu Elektrotlar Ø 5 mm x 330 mm /
450 mm**
Hook-tip electrodes Ø 5 mm x 330 mm / 450 mm

**Azami Ölçüde uca kadar izole edilmiş kanca
uçlu elektrot ,(modele bağlı arka izolelidir)**

Hook-tip electrodes insulated on the front, to max. extent
as well as on the back, up to the tip



**28-00100 Elektrot kolu, -araç kolunu istenilen
uzunlukta ayarlamak için kullanılır.-**

28-00100

Endoser handle
for individual length
adjustment of the instrument arm



28-00011 Künt , Kıvrımlı 330 mm

28-00011

blunt curved,
length 330 mm

28-00111 Künt , Kıvrımlı 450 mm

28-00111

blunt curved,
length 450 mm



28-00012 Elmas Şekil, Keskin yüzey 330 mm

28-00012

diamond shaped cutting surface
length 330 mm

28-00112 Elmas Şekil, Keskin yüzey 450 mm

28-00112

diamond shaped cutting surface
length 450 mm



28-00013 Künt , 330 mm

28-00013

blunt,
length 330 mm

28-00113 Künt , 450 mm

28-00113

blunt,
length 450 mm



28-00014 Elmas Şekil, Keskin yüzey 330 mm

28-00014

diamond shaped cutting surface
length 330 mm

28-00114 Elmas Şekil, Keskin yüzey 450 mm

28-00114

diamond shaped cutting surface
length 450 mm



28-00015 Elmas Şekil, Keskin yüzey 330 mm

28-00015

diamond shaped cutting surface
length 330 mm

28-00115 Elmas Şekil, Keskin yüzey 450 mm

28-00115

diamond shaped cutting surface
length 450 mm

Monopolar Elektrot Ø 5 mm x 330 mm / 450 mm
Monopolar electrode Ø 5 mm x 330 mm / 450 mm



28-00020 Düğme uçlu elektrot 330 mm

28-00020

Button tip electrode
length 330 mm

28-00120 Düğme uçlu elektrot 450 mm

28-00120

Button tip electrode
length 450 mm



28-00024 Spatula Uçlu Elektrot, 330
mm

28-00024











Spatula tip electrode
length 330 mm

28-00124 Spatula Uçlu Elektrot, 450
mm









28-00124

Spatula tip electrode
length 450 mm

Vakumlu Elektrot Ø 5 mm x 300
Electrodes with suction Ø 5 mm x 300

| | | | |
|----------|--|----------|--|
| | | |  |
| |  | | |
| 27-00001 | Boru-Vana ile izole edilmiş Pıhtılaştırma ve Vakum Kanülü | | 27-00001 Coagulation and suction-canula, insulated with trumpet valve |
| |  | | |
| 27-00002 | Boru-Vana ile izole edilmiş Diseksiyon Spatulası | 27-00002 | Dissecting Spatula, insulated with trumpet valve |
| |  | | |
| 27-00003 | Boru-Vana ile izole edilmiş Diseksiyon Kancası | 27-00003 | Dissecting Hook, insulated with trumpet valve |
| |  | | |
| 27-00004 | Boru-Vana ile izole edilmiş Dik Açılı Diseksiyon Kancası | 27-00004 | Dissecting Hook right-angled, insulated with trumpet valve |
| | | |  |
| |  | | |
| 27-00011 | Pıhtılaştırma ve Vakum Kanülü, İzolasyonlu | 27-00011 | Coagulation and suction-canula, insulated |
| |  | | |
| 27-00012 | Diseksiyon Spatulası, İzolasyonlu | 27-00012 | Dissecting Spatula, insulated |
| |  | | |
| 27-00013 | Diseksiyon Kancası, İzolasyonlu | 27-00013 | Dissecting Hook, insulated |
| |  | | |
| 27-00014 | Dik Açılı Diseksiyon Kancası, İzolasyonlu | 27-00014 | Dissecting Hook right-angled, insulated |

Vakum-Sulama Boruları Ø 5/10 mm x 330
Suctions and Irrigation Tubes Ø 5/10 mm x 330

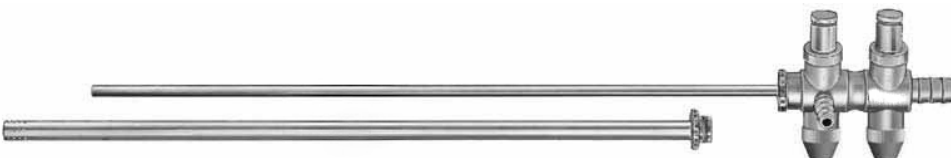
| | | | |
|----------|---|----------|--|
| | | |  |
| 27-00600 | Vakum-Sulama Boru seti Ø 5 mm: 7 adet vakum-sulama borusu ve 1 Adet sürgülü vana içerir. | 27-00600 | Suction-Irrigation tube set Ø 5 mm consisting of: 7 x Suction/Irrigation tube fig. 1-7 1 x Sliding valve |
| 27-00601 | Sürgülü Vana | 27-00601 | Sliding valve only |
| | | |  |
| 27-00602 | Vakum-Sulama Boru seti Ø 5 mm: 7 adet vakum-sulama borusu ve 1 Adet boru tip vana içerir. | 27-00602 | Suction-Irrigation tube set Ø 5 mm consisting of: 7 x Suction/Irrigation tube fig. 1-7 1 x Trumpet valve |
| 27-00603 | Sadece Boru Tip Vana | 27-00603 | Trumpet valve only |
| | | |  |
| 27-00610 | Vakum-Sulama Borusu Şkl:1 | 27-00610 | Suction-Irrigation tube fig. 1 |
| | | |  |
| 27-00611 | Vakum-Sulama Borusu Şkl:2 | 27-00611 | Suction-Irrigation tube fig. 2 |
| | | |  |
| 27-00612 | Vakum-Sulama Borusu Şkl:3 | 27-00612 | Suction-Irrigation tube fig. 3 |
| 27-00613 | Vakum-Sulama Borusu Şkl:4 ,500mm uzunluk | 27-00613 | Suction-Irrigation tube fig. 4 length 500 mm |
| | | |  |
| 27-00614 | Vakum-Sulama Borusu Şkl:5 | 27-00614 | Suction-Irrigation tube fig. 5 |
| | | |  |
| 27-00615 | Vakum-Sulama Borusu Şkl:6 | 27-00615 | Suction-Irrigation tube fig. 6 |
| | | |  |
| 27-00616 | Vakum-Sulama Borusu Şkl:7 | 27-00616 | Suction-Irrigation tube fig. 7 |
| | | |  |
| 27-00620 | Vakum-sulama Boru Seti : | 27-00620 | Suction-Irrigation tube set consisting of: |
| 27-00621 | Vakum-Sulama Borusu Ø 5 mm | 27-00621 | Suction-Irrigation tube Ø 5 mm |
| 27-00622 | Vakum-Sulama Borusu Ø 10 mm | 27-00622 | Suction-Irrigation tube Ø 10 mm |
| 27-00623 | Sadece Boru-Vana | 27-00623 | Trumpet valve |

Vakum-Sulama Tabanca Kolu

Suction-Irrigation Pistol handle



27-00630 Vakum-Sulama Tabanca Kolu Çift Yönlü , Sürgülü Vanalı 27-00630 Suction-Irrigation Pistol handle with 2-way sliding valve

27-00631 Vakum-Sulama Borusu Ø 3 mm 27-00631 Suction-Irrigation tube Ø 3 mm
27-00632 Vakum-Sulama Borusu Ø 5 mm 27-00632 Suction-Irrigation tube Ø 5 mm

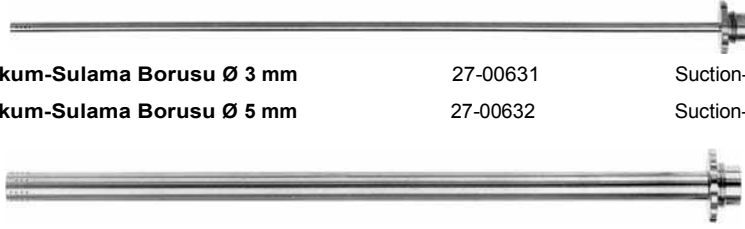

27-00633 Vakum-Sulama Borusu Ø 10 mm 27-00633 Suction-Irrigation tube Ø 10 mm

Enjeksiyon ve Delme İğnesi

Injection and puncture needle



27-00041 Enjeksiyon ve Delme İğnesi , Ø 10 mm, Luer Kilitli 27-00041 Injection and puncture needle, Ø 5 mm, Luer Lock

Konektörler

Connectors



27-00015 Konektör, Ø 6mm Dişi Luer Kilitli 27-00015 Connector with Luer Lock Ø 6 mm (female)



27-00017 Konektör, Ø 6mm Erkek Luer Kilitli 27-00017 Connector with Luer Lock Ø 6 mm (male)

Laparoskopi Aksesuarları / Kolesistektomi

Accessories for Laparoscopy / Cholecystectomy



27-00039 Kolanjiyografi Tespit Forsepsi Ø 5 mm 27-00039 Cholangiography Fixation forceps Ø 5 mm

YENİ ENDOSER LAPAROSKOPİ CİHAZLARI

Endoser, en yeni laparoskopi ürün hattını size sunuyor, "Kolay Değişim".

Ergonomik hafif tasarım, mükemmel temizleme özelliği, hızlı, etkin ve basit. Ayrıca, ekstra hızlı temizleme imkanı olan "Luer Lock" kilitleme sistemi de bütün ürünlere eklendi. Tek parmağınızla basarak, çok kolay bir şekilde kaldırılabilen hareket kolları mevcut, bu kadar hızlı kilitleme başka hiçbir uzunlukta ve başka hiçbir vida da mümkün olmamıştır.

Kolay tutuş için yeni ve konforlu mandallar geliştirdik. Böylece, kullanıcıların parmaklarının duruşu sanki mandalsız bir kol tutar gibi rahat oluyor. Geleneksel mandallı kollardaki engeller ve zorluklar da giderildi.

"Kolay Değişim" hattı, 5 mm ve 10 mm seçenekler ile mevcuttur. Hem de her iki boyda ekleri aynı kulpla kullanabilirsiniz. Bütün ürünler 360° dönebilir ve otoklavlanabilir. Ürünler kolayca kulp, dış tüp ve çalışma eki olarak 3 parçaya ayrılabilir.

NEW ENDOSER LAPAROSCOPY "easy change" INSTRUMENT LINE-

The following benefits offers the newest Laparoscopy instrument line „easy change“:

Ergonomic light design, excellent cleaning quality e.g. fast, effective and simple.

Every instruments features additionally extra fast cleaning possibility via „Luer Lock“.

Very easy and simple handling as handle can be removed by pressing with one finger, this corresponds to a quick lock as no screws are used any longer.

For handles with ratchet we developed a new comfortable ratchet design with easy handling. The users finger posture is the same like holding a handle without ratchet.





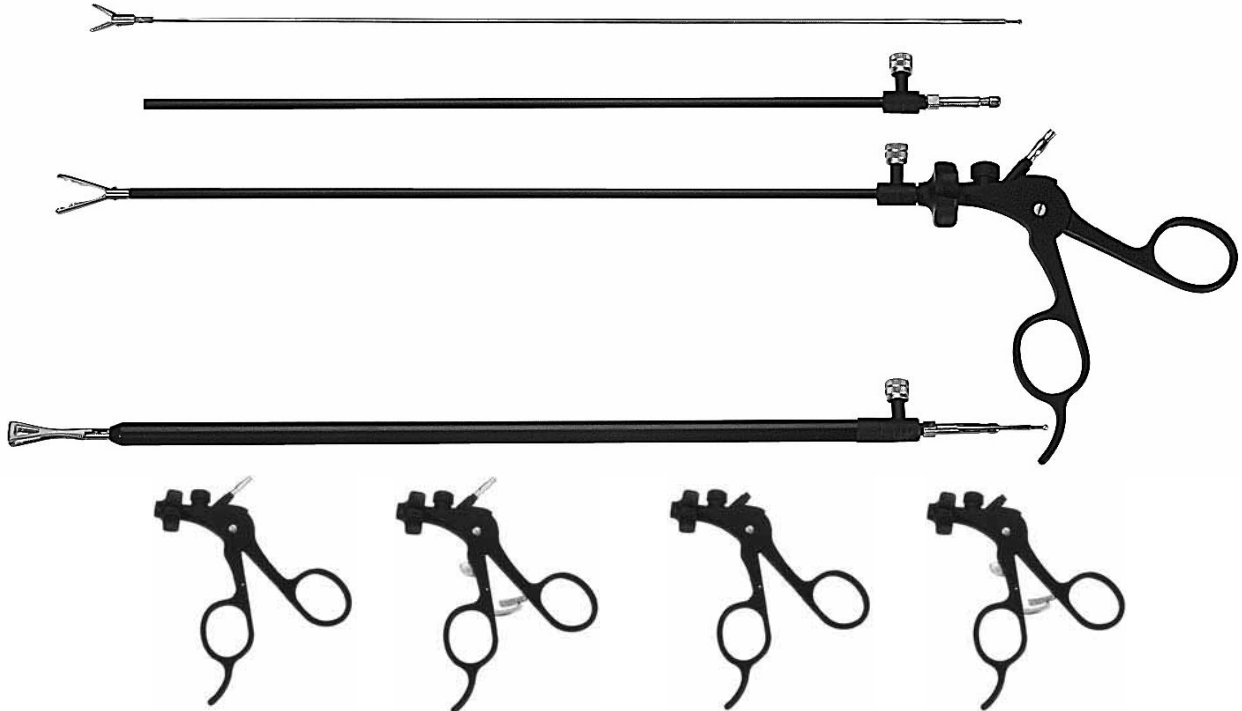



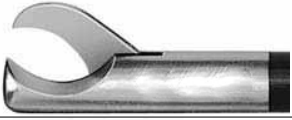

The handicap through the traditional ratchet on the handle is cancelled.

„Easy change line“ is in 5mm and in 10mm available. NEW !! for 5mm inserts as well as for the 10mm you use the same handle. All instruments are 360° rotatable and autoclavable. Can be taken apart fast and easily into 3 parts: handle, outer tube and working insert.



Biyopsi Forsepsler Ø 5mm
Scissors, Biopsy forceps Ø 5mm

"easy change"

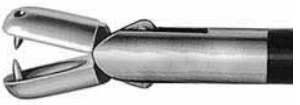
| | Uzunluk Working length | Kol Handle 36-000-001 | Kol Handle 36-000-003 | Kol Handle 36-000-005 | Kol Handle 36-000-007 |
|---|---------------------------|--|---|--|---|
| | | 330 mm 430 mm |  |  |  |
| | Ürün No. Insert no. | Aletin Tamamı - 5 mm Complete Instrument 5 mm | | | |
|  | | Kanca Makas,Düz Hook scissors, straight | | | |
| | 36-051-000 | 36-051-101 | | | |
| | 37-051-000 | 37-051-101 | | | |
|  | | Periton Makas, Düz Peritoneal scissors, straight | | | |
| | 36-082-000 | 36-082-101 | | | |
| | 37-082-000 | 37-082-101 | | | |
|  | | Mikro diseksiyon makas ,Düz Micro dissecting scissors, straight | | | |
| | 36-048-000 | 36-048-101 | | 36-048-105 | |
|  | | Mikro diseksiyon makas, Sola Kıvrımlı Micro dissecting scissors, curved left | | | |
| | 36-049-000 | 36-049-101 | | 36-049-105 | |
|  | | METZENBAUM, diseksiyon makas, kısa , kıvrımlı METZENBAUM, Dissecting scissors, short, curved | | | |
| | 36-047-000 | 36-047-101 | | | |
|  | | METZENBAUM, diseksiyon makas ,Düz METZENBAUM, Dissecting scissors, straight | | | |
| | 36-054-000 | 36-054-101 | | | |
| | 37-054-000 | 37-054-101 | | | |
|  | | METZENBAUM, diseksiyon makas, kıvrımlı METZENBAUM, Dissecting scissors, curved | | | |
| | 36-056-000 | 36-056-101 | | | |
| | 37-056-000 | 37-056-101 | | | |
|  | | Biyopsi forseps Biopsy forceps | | | |
| | 36-063-000 | 36-063-101 | | | |
| | 37-063-000 | 37-063-101 | | | |
|  | | Biyopsi Forseps / İğneli Biopsy forceps /Thorn | | | |
| | 36-064-000 | 36-064-101 | 37-064-000 | 37-064-101 | |

Dış Boru 330 mm 36-000-100 5mm
Outer tube 430 mm 37-000-100 5mm













Ayrıca tüm diğer kombinasyonların siparişi de alınmaktadır.

All further handle-combinations are also possible of course.

Kolay Değişim teknolojisi ile, aletler uçlarına kadar yalıtılmışlardır.

The advantage of the new „easy change“-instrument is the insulation, which reaches until the tip of the instrument.

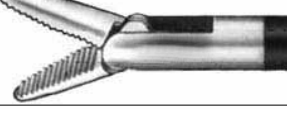
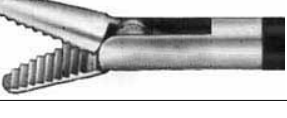
Biyopsi Forsepsler, Pañçlar ve Kavrayıcılar Ø 5mm "easy change"
 Biopsy Forceps, -Punches and Grasping Forceps Ø 5mm

| | Uzunluk Working length | Kol 36-000-001 | Kol Handle 36-000-003 | Kol Handle 36-000-005 | Kol Handle 36-000-007 |
|---|---------------------------|---|--|---|---|
| | 330 mm 430 mm |  |  |  |  |
| Ürün Nr. Insert no. | | Komple Cihaz/ 5 mm Complete Instrument 5 mm | | | |
|  | | BLAKESLY , Biyopsi Forseps <i>BLAKESLY, Biopsy forceps</i> | | | |
| | 36-081-000 | 36-081-101 | | | |
| | 37-081-000 | 37-081-101 | | | |
|  | | Biyopsi Pañç Biopsy punch | | | |
| | 36-060-000 | 36-060-101 | | | |
| | 37-060-000 | 37-060-101 | | | |
|  | | Biyopsi Pañç Biopsy punch | | | |
| | 36-062-000 | 36-062-101 | | | |
| | 37-062-000 | 37-062-101 | | | |
|  | | Kavrayıcı Forseps Grasping forceps | | | |
| | 36-065-000 | 36-065-101 | 36-065-103 | | |
| | 37-065-000 | 37-065-101 | 37-065-103 | | |
|  | | Fenestre Kavrayıcı Grasping forceps Fenestrated | | | |
| | 36-079-000 | | 36-079-103 | | |
| | 37-079-000 | | 37-079-103 | | |
|  | | Kavrayıcı Forseps, Narin Desen Grasping forceps, delicate pattern | | | |
| | 36-066-000 | | 36-066-103 | | |
| | 37-066-000 | | 37-066-103 | | |
|  | | Kavrayıcı Forseps, Kaba Desen Grasping forceps, heavy pattern | | | |
| | 36-078-000 | | 36-078-103 | | |
| | 37-078-000 | | 37-078-103 | | |
|  | | Kavrayıcı Forseps Grasping forceps | | | |
| | 36-068-000 | | 36-068-103 | | |
| | 37-068-000 | | 37-068-103 | | |
|  | | Kavrayıcı Forseps, Sivri Grasping forceps, pointed | | | |
| | 36-069-000 | | 36-069-103 | | |
| | 37-069-000 | | 37-069-103 | | |

Dış Boru 330 mm 36-000-100 5mm
 Outer tube 430 mm 37-000-100 5mm

Ayrıca tüm diğer kombinasyonların siparişi de alınmaktadır.













All further handle-combinations are also possible of course.

Kolay Değişim teknolojisi ile, aletler uçlarına kadar yalıtılmışlardır.

The advantage of the new „easy change“-instrument is the insulation, which reaches until the tip of the instrument.

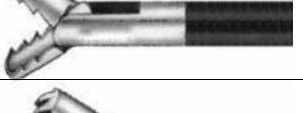

Kavrayıcı ve Diseksiyon Forsepsler Ø 5mm
Grasping and Dissecting Forceps Ø 5mm

| | Uzunluk Working length | Kol Handle 36-000-001 | Kol Handle 36-000-003 | Kol Handle 36-000-005 | Kol Handle 36-000-007 |
|---|---------------------------|---|--|---|---|
| | 330 mm 430 mm |  |  |  |  |
| | Ürün Nr. Insert no. | Komple Cihaz 5 mm Complete Instrument 5 mm | | | |
|  | | Kavrayıcı Forseps Grasping forceps | | | |
| | 36-075-000 | | 36-075-103 | | |
| | 37-075-000 | | 37-075-103 | | |
|  | | Diseksiyon Forseps, Atravmatik Dissecting forceps, atraumatic | | | |
| | 36-070-000 | 36-070-101 | 36-070-103 | | |
| | 37-070-000 | 37-070-101 | 37-070-103 | | |
|  | | MARYLAND, Diseksiyon Forsepsi, Kıvrımlı MARYLAND, Dissecting forceps, curved | | | |
| | 36-072-000 | 36-072-101 | | | |
| | 37-072-000 | 37-072-101 | | | |
|  | | Diseksiyon Forsepsi, 45° Kıvrımlı Dissecting forceps, curved 45° | | | |
| | 36-246-000 | 36-246-101 | | 36-246-105 | |
| | 37-246-000 | 37-246-101 | | 37-246-105 | |
|  | | Diseksiyon Forsepsi, 90° Kıvrımlı Dissecting forceps, curved 90° | | | |
| | 36-247-000 | 36-247-101 | | 36-247-105 | |
|  | | Kavrayıcı Forseps, atravmatik, De Bakey Grasping forceps, atraumatic, De Bakey | | | |
| | 36-242-000 | | 36-242-103 | | 36-242-107 |
| | 37-242-000 | | 37-242-103 | | 37-242-107 |
|  | | Kavrayıcı Forseps Grasping forceps | | | |
| | 36-077-000 | | 36-077-103 | | |
| | 37-077-000 | | 37-077-103 | | |
|  | | Kavrayıcı Forseps, 2x3 Dişli Grasping forceps 2x3 teeth | | | |
| | 36-076-000 | | 36-076-103 | | |
| | 37-076-000 | | 37-076-103 | | |
|  | | Kavrayıcı Forseps ,Tungsten Karbürü Grasping forceps HI with tungsten carbide | | | |
| | 36-286-000 | | 36-286-103 | | 36-286-107 |
| | 37-286-000 | | 37-286-103 | | 37-286-107 |

Dış Boru 330 mm 36-000-100 5mm
Outer tube 430 mm 37-000-100 5mm









Ayrıca tüm diğer kombinasyonların siparişi de alınmaktadır.
All further handle-combinations are also possible of course.

Kolay Değişim teknolojisi ile, aletler uçlarına kadar yalıtılmışlardır.

The advantage of the new „easy change“-instrument is the insulation, which reaches until the tip of the instrument.

Kavrayıcı ve Disksiyon Forsepsler, İğne Tutucular *"easy change"* Grasping-, Dissecting Forceps and Needle Holders Ø 5mm

| | Uzunluk Working length | Kol Handle 36-000-001 | Kol Handle 36-000-003 | Kol Handle 36-000-005 | Kol Handle 36-000-007 |
|---|---|---|--|---|---|
| | 330 mm |  |  |  |  |
| Ürün Nr. Insert no. | Komple Cihaz 5 mm Complete Instrument 5 mm | | | | |
|  | | Pençe Forseps ,2x3 Dişli Claw forceps 2x3 teeth | | | |
| 36-083-000 | | | 36-083-103 | | 36-083-107 |
|  | | ALLIS , Kavrayıcı Forseps ALLIS, Grasping forceps | | | |
| 36-105-000 | | | 36-105-103 | | 36-105-107 |
|  | | ALLIS, Kavrayıcı Forseps , Atravmatik , De Bakey ALLIS, Grasping forceps, atraumatic, De Bakey | | | |
| 36-111-000 | | | 36-111-103 | | 36-111-107 |
|  | | Endo-Forceps, tek De Bakey ,Yakın Korumalı Endo-Forceps with single De Bakey, closing protection | | | |
| 36-198-000 | | | 36-198-103 | | 36-198-107 |
|  | | KOCHER kavrayıcı forseps, Atravmatik, De bakey KOCHER, Grasping forceps, atraumatic, De Bakey | | | |
| 36-171-000 | | | 36-171-103 | | 36-171-107 |
|  | | Endo-Lung Palpasyon Forsepsi Endo-Lung Palpation forceps | | | |
| 36-233-000 | | 36-233-101 | | 36-233-105 | |
|  | | Diseksiyon Forspesi 90° kıvrımlı, 12,5 mm trokar kılıfı ile kullanılır. Dissecting forceps curved 90°, used with 12,5 mm trocar sleeve | | | |
| 36-067-000 | | 36-067-101 | | 36-067-105 | |
|  | | İğne Tutucu, tungsten karbürü Needle holder with tungsten carbide inserts 8 mm | | | |
| 36-201-000 | | | | | 36-201-107 |
|  | | Dikiş Sabitleme forsepsi , U-şeklinde ağız Suture fixation forceps, U-shaped jaws | | | |
| 36-248-000 | | | | | 36-248-107 |

Dış Boru
Outer tube

330 mm

36-000-100

5mm



Ayrıca tüm diğer kombinasyonların siparişi de alınmaktadır.

All further handle-combinations are also possible of course.



Kolay Değişim teknolojisi ile, aletler uçlarına kadar yalıtılmışlardır.

The advantage of the new „easy change“-instrument is the insulation, which reaches until the tip of the instrument.

Kavrayıcı ve Diseksiyon Forsepsler Ø 5mm+10 mm
Grasping and Dissection Forceps Ø 5+10mm

"easy change"

| | Uzunluk Working length | Kol Handle 36-000-001 | Kol Handle 36-000-003 | Kol Handle 36-000-005 | Kol Handle 36-000-007 |
|---|--|---|--|---|---|
| | 330 mm |  |  |  |  |
| Ürün No: Insert no. | Komple Cihaz 5mm Complete Instrument 5 mm | | | | |
|  | 36-244-000 | Kavrayıcı Forseps , Sıkı Tutmak için, Atravmatik Grasping forceps Clinch, atraumatic | | 36-244-103 | 36-244-107 |
|  | 36-288-000 | BABCOCK, Kavrayıcı Forseps BABCOCK, Grasping forceps | | 36-288-103 | 36-288-107 |
|  | 36-071-000 | 36-071-101 | 36-071-103 | | 36-071-107 |
|  | 36-249-000 | Kavrayıcı Forseps , DORSEY Grasping forceps, DORSEY | | 36-249-103 | 36-249-107 |

| | Ürün No. Insert no. | Komple Cihaz 10 mm Complete Instrument 10 mm | | | |
|---|------------------------|--|------------|------------|------------|
|  | 36-176-000 | DUVAL , Kavrayıcı Forseps DUVAL Grasping forceps | | 36-176-203 | 36-176-207 |
|  | 36-181-000 | COLLIN Kavrayıcı Forseps , Atravmatik COLLIN Grasping forceps, atraumatic | | 36-181-203 | 36-181-207 |
|  | 36-080-000 | 36-080-201 | 36-080-203 | | |

Dış Boru 330 mm 36-000-100 5mm
Outer tube 330 mm 36-000-200 10mm



Ayrıca tüm diğer kombinasyonların siparişi de alınmaktadır.













All further handle-combinations are also possible of course.

Kolay Değişim teknolojisi ile, aletler uçlarına kadar yalıtılmışlardır.

The advantage of the new „easy change“-instrument is the insulation, which reaches until the tip of the instrument.

Araç-Gereçler Ø 10mm
Instruments Ø 10mm

"easy change"

| | Uzunluk Working length | Kol Handle 36-000-001 | Kol Handle 36-000-003 | Kol Handle 36-000-005 | Kol Handle 36-000-007 |
|---|---------------------------|---|--|---|---|
| | 330 mm |  |  |  |  |
| | Ürün Nr. Insert no. | Komple Cihaz 10 mm Complete Instrument 10 mm | | | |
|  | 36-084-000 | 36-084-201 | | 36-084-205 | |
|  | 36-180-000 | 36-180-201 | 36-180-203 | | 36-180-207 |
|  | 36-179-000 | | 36-179-203 | | 36-179-207 |
|  | 36-225-000 | | 36-225-203 | | 36-225-207 |
|  | 36-074-000 | 36-074-201 | 36-074-203 | | |
|  | 36-101-000 | | 36-101-203 | | 36-101-207 |
|  | 36-108-000 | | 36-108-203 | | 36-108-207 |
|  | 36-120-000 | | 36-120-203 | | 36-120-207 |
|  | 36-123-000 | | 36-123-203 | | 36-123-207 |

Dış Boru
Outer tube

330 mm

36-000-200

10mm











Ayrıca tüm diğer kombinasyonların siparişi de alınmaktadır.
All further handle-combinations are also possible of course.

Kolay Değişim teknolojisi ile, aletler uçlarına kadar yalıtılmışlardır.

The advantage of the new „easy change“-instrument is the insulation, which reaches until the tip of the instrument.

Kavrayıcı, Palpasyon ve Endo-Forsepsleri. Ø 10mm *"easy change"*
Grasping, Palpation and Endo-Forceps Ø 10mm

| Çalışma Uzunluğu Working length | Çene Uzunluğu Jaw length | Kol Handle 36-000-001 | Kol Handle 36-000-003 | Kol Handle 36-000-005 | Kol Handle 36-000-007 |
|---|-----------------------------|---|--|---|---|
| 330 mm | 50 mm 60 mm |  |  |  |  |
| | Ürün Nr. Insert no. | Komple Cihaz 10 mm Complete Instrument 10 mm | | | |
|  | | KOCHER, Kavrayıcı Forseps, Atravmatik KOCHER, Grasping forceps, atraumatic | | | |
| | 36-132-000 | | 36-132-203 | | 36-132-207 |
| | 36-135-000 | | 36-135-203 | | 36-135-207 |
|  | | KOCHER, Kavrayıcı Forseps, Atravmatik, tek De Bakey KOCHER, Grasping forceps, atraumatic, single De Bakey | | | |
| | 36-147-000 | | 36-147-203 | | 36-147-207 |
| | 36-150-000 | | 36-150-203 | | 36-150-207 |
|  | | KOCHER, Kavrayıcı Forseps, atravmatik, çift De Bakey KOCHER, Grasping forceps, atraumatic, double De Bakey | | | |
| | 36-162-000 | | 36-162-203 | | 36-162-207 |
| | 36-165-000 | | 36-165-203 | | 36-165-207 |
|  | | Endo-Forsepsler, tek De Bakey ,yakın korumalı Endo-Forceps, single De Bakey with closing protection | | | |
| | 36-196-000 | | 36-196-203 | | 36-196-207 |
| | 36-197-000 | | 36-197-203 | | 36-197-207 |
|  | | Endo-Forsepsler, çift De Bakey Yakın Korumalı Endo-Forceps, double De Bakey with closing protection | | | |
| | 36-192-000 | | 36-192-203 | | 36-192-207 |
| | 36-193-000 | | 36-193-203 | | 36-193-207 |

Dış Boru
Outer tube

330 mm 36-000-200 10mm



Ayrıca tüm diğer kombinasyonların siparişi de alınmaktadır.
All further handle-combinations are also possible of course.

Kolay Değişim teknolojisi ile, aletler uçlarına kadar yalıtılmışlardır.

The advantage of the new „easy change“-instrument is the insulation, which reaches until the tip of the instrument.

Dönebilen ve Sökülebilir Aletler Rotating and Detachable Instruments

Onaylanmış uzun araç tasarımlarımız sayesinde, her bir temel araç parçaları farklı kollar ile uyumlu kombine edilebilir.

Bu sayede, eğer araç uçlarında aşınma meydana gelirse, sadece yeni bir uç olarak tasarruf edersiniz. Eski modellerdeki gibi komple bir araç satın almanıza gerek yoktur.

Endoser ayrılabilir parçalar size en iyi enfeksiyona karşı koruma da sağlar. Bu kullanıcı dostu parçalar kolaylıkla sökülüp takılabilir ve temizlenebilir. Tek tek sipariş edilebilir parçalar sayesinde maliyetinizi açıkça düşürmüş olacaksınız.

Through the principle of the design of these long approved instruments, the basic elements of each instrument can be combined with different handles.

In case of erosion of the instruments insert, it can be replaced by a new one. This leads to a clear lowering of costs, as only the instruments insert has to be exchanged and not the complete instrument.

The detachable Endoser instruments offer therefore best possible protection against infection, and they are user-friendly through a easy disassembly and the combination of the instrument inserts with various handles. As the basic elements like handle and instrument insert can be ordered separately they are cost lowering. These instruments offer a clearly improved cost use relation.

MONTE EDİLMİŞ ARAÇ

ASSEMBLED INSTRUMENT















SÖKÜLMÜŞ ARAÇ

DISASSEMBLED INSTRUMENT



Makaslar, Biyopsi Forsepsler Ø 5mm
Scissors, Biopsy Forceps Ø 5mm











| | Uzunluk Working length | Kol Handle 28-000-001 | Kol Handle 28-000-003 | Kol Handle 28-000-005 | Kol Handle 28-000-007 |
|---|---------------------------|---|--|---|---|
| | 330 mm 430 mm |  |  |  |  |
| | Ürün Nr. Insert no. | Komple Cihaz 5 mm Complete Instrument 5 mm | | | |
|  | | Kanca Makas , Düz Hook scissors, straight | | | |
| | 28-051-000 | 28-051-101 | | | |
| | 26-051-000 | 26-051-101 | | | |
|  | | Periton Makasları , Düz Peritoneal scissors, straight | | | |
| | 28-082-000 | 28-082-101 | | | |
| | 26-082-000 | 26-082-101 | | | |
|  | | Mikro-Diseksiyon Makasları, Düz Micro dissecting scissors, straight | | | |
| | 28-048-000 | 28-048-101 | | 28-048-105 | |
|  | | Mikro-Diseksiyon Makasları, Sola Kıvrımlı Micro dissecting scissors, curved left | | | |
| | 28-049-000 | 28-049-101 | | 28-049-105 | |
|  | | METZENBAUM, Diseksiyon makasları, kısa , kıvrımlı METZENBAUM, Dissecting scissors, short, curved | | | |
| | 28-047-000 | 28-047-101 | | | |
|  | | METZENBAUM, Diseksiyon Makasları, Düz METZENBAUM, Dissecting scissors, straight | | | |
| | 28-054-000 | 28-054-101 | | | |
| | 26-054-000 | 26-054-101 | | | |
|  | | METZENBAUM, Diseksiyon Makasları, Kıvrımlı METZENBAUM, Dissecting scissors, curved | | | |
| | 28-056-000 | 28-056-101 | | | |
| | 26-056-000 | 26-056-101 | | | |
|  | | Biyopsi Forseps Biopsy forceps | | | |
| | 28-063-000 | 28-063-101 | | | |
| | 26-063-000 | 26-063-101 | | | |
|  | | Biyopsi Forseps, İğneli Biopsy forceps with thorn | | | |
| | 28-064-000 | 28-064-101 | | | |
| | 26-064-000 | 26-064-101 | | | |

Dış Boru 330 mm 28-000-100 5mm
Outer tube 430 mm 26-000-100 5mm

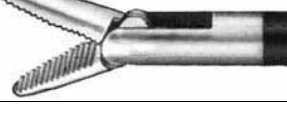
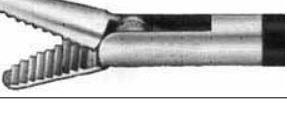

Ayrıca tüm diğer kombinasyonların siparişi de alınmaktadır.
All further handle-combinations are also possible of course.

Biyopsi ve Kavrayıcı Forsepsler Ø 5mm
Biopsy Forceps, -Punches and Grasping Forceps Ø 5mm

| | Uzunluk Working length | Kol Handle 28-000-001 | Kol Handle 28-000-003 | Kol Handle 28-000-005 | Kol Handle 28-000-007 |
|---|---------------------------|---|--|---|---|
| | 330 mm 430 mm |  |  |  |  |
| | Ürün Nr. Insert no. | Komple Cihaz 5 mm Complete Instrument 5 mm | | | |
|  | | BLAKESLY, Biyopsi Forseps BLAKESLY, Biopsy forceps | | | |
| | 28-081-000 | 28-081-101 | | | |
| | 26-081-000 | 26-081-101 | | | |
|  | | Biyopsi Paç Biopsy punch | | | |
| | 28-060-000 | 28-060-101 | | | |
| | 26-060-000 | 26-060-101 | | | |
|  | | Biyopsi Paç Biopsy punch | | | |
| | 28-062-000 | 28-062-101 | | | |
| | 26-062-000 | 26-062-101 | | | |
|  | | Kavrayıcı Forsepsler Grasping forceps | | | |
| | 28-065-000 | | 28-065-103 | | |
| | 26-065-000 | | 26-065-103 | | |
|  | | Fenestre Kavrayıcı Forseps Grasping forceps Fenestrated | | | |
| | 28-079-000 | | 28-079-103 | | |
| | 26-079-000 | | 26-079-103 | | |
|  | | Kavrayıcı Forseps, Narin Desen Grasping forceps, delicate pattern | | | |
| | 28-066-000 | | 28-066-103 | | |
| | 26-066-000 | | 26-066-103 | | |
|  | | Kavrayıcı Forseps, Kaba Desen Grasping forceps, heavy pattern | | | |
| | 28-078-000 | | 28-078-103 | | |
| | 26-078-000 | | 26-078-103 | | |
|  | | Kavrayıcı Forseps Grasping forceps | | | |
| | 28-068-000 | | 28-068-103 | | |
| | 26-068-000 | | 26-068-103 | | |
|  | | Kavrayıcı Forseps, SIVRI Grasping forceps, pointed | | | |
| | 28-069-000 | | 28-069-103 | | |
| | 26-069-000 | | 26-069-103 | | |

Dış Boru
Outer tube

330 mm
430 mm













28-000-100
26-000-100

5mm
5mm



Ayrıca tüm diğer kombinasyonların siparişi de alınmaktadır.
All further handle-combinations are also possible of course.

Kavrayıcı ve diseksiyon Forsepsleri Ø 5mm
Grasping and Dissecting Forceps Ø 5mm













| | Uzunluk Working length | Kol Handle 28-000-001 | Kol Handle 28-000-003 | Kol Handle 28-000-005 | Kol Handle 28-000-007 |
|---|---------------------------|---|--|---|---|
| | 330 mm 430 mm |  |  |  |  |
| | Ürün Nr. Insert no. | Komple Cihaz 5 mm Complete Instrument 5 mm | | | |
|  | | Kavrayıcı Forseps Grasping forceps | | | |
| | 28-075-000 | | 28-075-103 | | |
| | 26-075-000 | | 26-075-103 | | |
|  | | Diseksiyon Forseps, Atravmatik Dissecting forceps, atraumatic | | | |
| | 28-070-000 | 28-070-101 | | | |
| | 26-070-000 | 26-070-101 | | | |
|  | | MARYLAND, Diseksiyon Forseps, Kıvrımlı MARYLAND, Dissecting forceps, curved | | | |
| | 28-072-000 | 28-072-101 | | | |
| | 26-072-000 | 26-072-101 | | | |
|  | | Diseksiyon Forseps, kıvrımlı 45° Dissecting forceps, curved 45° | | | |
| | 28-246-000 | 28-246-101 | | 28-246-105 | |
| | 26-246-000 | 26-246-101 | | 26-246-105 | |
|  | | Diseksiyon Forseps, kıvrımlı 90° Dissecting forceps, curved 90° | | | |
| | 28-247-000 | 28-247-101 | | 28-247-105 | |
|  | | Kavrayıcı, Atravmatik, De Bakey Grasping forceps, atraumatic, De Bakey | | | |
| | 28-242-000 | | 28-242-103 | | 28-242-107 |
| | 26-242-000 | | 26-242-103 | | 26-242-107 |
|  | | Kavrayıcı Froseps Grasping forceps | | | |
| | 28-077-000 | | 28-077-103 | | |
| | 26-077-000 | | 26-077-103 | | |
|  | | Kavrayıcı Froseps 2x3 Dişli Grasping forceps 2x3 teeth | | | |
| | 28-076-000 | | 28-076-103 | | |
| | 26-076-000 | | 26-076-103 | | |
|  | | Kavrayıcı Froseps, Tungsten Karbür Grasping forceps HI with tungsten carbide | | | |
| | 28-286-000 | | 28-286-103 | | 28-286-107 |
| | 26-286-000 | | 26-286-103 | | 26-286-107 |

Dış Boru 330 mm 28-000-100 5mm
Outer tube 430 mm 26-000-100 5mm



Ayrıca tüm diğer kombinasyonların siparişi de alınmaktadır.
All further handle-combinations are also possible of course.

Kavrayıcı -Diseksiyon Forsepsleri ve İğne Tutucular Ø 5mm
Grasping-, Dissecting Forceps and Needle Holders Ø 5mm

| | Uzunluk Working length | Kol Handle 28-000-001 | Kol Handle 28-000-003 | Kol Handle 28-000-005 | Kol Handle 28-000-007 |
|---|---------------------------|---|--|---|---|
| | 330 mm |  |  |  |  |
| | Ürün Nr. Insert no. | Komple Cihaz 5 mm Complete Instrument 5 mm | | | |
|  | | Pençe Forsepsi 2x3 Dişli Claw forceps 2x3 teeth | | | |
| | 28-083-000 | | 28-083-103 | | 28-083-107 |
|  | | ALLIS, Kavrayıcı Forseps ALLIS, Grasping forceps | | | |
| | 28-105-000 | | 28-105-103 | | 28-105-107 |
|  | | ALLIS, Kavrayıcı Forseps ,Atravmatik, De Bakey Allis, Grasping forceps, atraumatic, De Bakey | | | |
| | 28-111-000 | | 28-111-103 | | 28-111-107 |
|  | | Endo-Forseps, tek De Bakey ,yakın korumalı Endo-Forceps with single De Bakey, closing protection | | | |
| | 28-198-000 | | 28-198-103 | | 28-198-107 |
|  | | KOCHER, Kavrayıcı Forseps , Atravmatik, De Bakey KOCHER, Grasping forceps, atraumatic, De Bakey | | | |
| | 28-171-000 | | 28-171-103 | | 28-171-107 |
|  | | Endo-Akciğer Palpasyon Forsepsi Endo-Lung Palpation forceps | | | |
| | 28-233-000 | 28-233-101 | | 28-233-105 | |
|  | | Diseksiyon Forsepsi kıvrımlı 90° , 12,5mm trokar kılıfı ile kullanılır Dissecting forceps curved 90° , used with 12,5 mm trocar sleeve | | | |
| | 28-067-000 | 28-067-101 | | | |
|  | | İğne tutucu 8 mm, tungsten karbür kaplama Needle holder with tungsten carbide inserts 8 mm | | | |
| | 28-201-000 | | | | 28-201-107 |
|  | | Dikiş Sabitleme Forsepsi. U ağız Suture fixation forceps, U-shaped jaws | | | |
| | 28-248-000 | | | | 28-248-107 |

Dış Boru
Outer tube

330 mm













28-000-100

5mm



Ayrıca tüm diğer kombinasyonların siparişi de alınmaktadır.
All further handle-combinations are also possible of course.

Aletler Ø 10mm
Instruments Ø 10mm

| | Uzunluk Working length | Kol Handle 28-000-002 | Kol Handle 28-000-004 | Kol Handle 28-000-006 | Kol Handle 28-000-008 |
|---|---------------------------|---|--|---|---|
| | 330 mm |  |  |  |  |
| | Ürün Nr. Insert no. | Komple Cihaz 10 mm Complete Instrument 10 mm | | | |
|  | 28-084-000 | 28-084-202 | | 28-084-206 | |
|  | 28-180-000 | | 28-180-204 | | 28-180-208 |
|  | 28-179-000 | | 28-179-204 | | 28-179-208 |
|  | 28-225-000 | | 28-225-204 | | 28-225-208 |
|  | 28-074-000 | 28-074-202 | | | |
|  | 28-101-000 | | 28-101-204 | | 28-101-208 |
|  | 28-108-000 | | 28-108-204 | | 28-108-208 |
|  | 28-120-000 | | 28-120-204 | | 28-120-208 |
|  | 28-123-000 | | 28-123-204 | | 28-123-208 |

Diş boru
Outer tube

330 mm







28-000-200

10mm



Ayrıca tüm diğer kombinasyonların siparişi de alınmaktadır.
All further handle-combinations are also possible of course.

Kavrayıcı ve Diseksiyon Forsepsleri Ø 10mm
Grasping and Dissection Forceps Ø 10mm

| | | | | | |
|--|---------------------------|---|--|---|---|
| | uzunluk Working length | Kol Handle 28-000-002 | Kol Handle 28-000-004 | Kol Handle 28-000-006 | Kol Handle 28-000-008 |
| | 330 mm |  |  |  |  |
| | Ürün Nr. Insert no. | Komple Cihaz 10 mm Complete Instrument 10 mm | | | |
|  | | DUVAL Kavrayıcı forceps DUVAL Grasping forceps | | | |
| | 28-176-000 | | 28-176-204 | | 28-176-208 |
|  | | COLLIN Kavrayıcı forceps, Atravmatik COLLIN Grasping forceps, atraumatic | | | |
| | 28-181-000 | | 28-181-204 | | 28-181-208 |
|  | | Diseksiyon Forseps, Atravmatik, De Bakey Dissecting-Grasping forceps, atraumatic, De Bakey | | | |
| | 28-080-000 | 28-080-202 | | | |

Dış Boru
Outer tube









330 mm

28-000-200 10mm



Ayrıca tüm diğer kombinasyonların siparişi de alınmaktadır.
All further handle-combinations are also possible of course.

Kavrayıcı, Palpasyon ve Endo Forsepsler Ø 10mm
Grasping, Palpation and Endo-Forceps Ø 10mm

| Uzunluk Working length | Çene Uzunluğu Jaw length | Kol Handle 28-000-002 | Kol Handle 28-000-004 | Kol Handle 28-000-006 | Kol Handle 28-000-008 |
|---|-----------------------------|---|--|---|---|
| 330 mm | 50 mm 60 mm |  |  |  |  |
| | Ürün Nr. Insert no. | Komple Cihaz 10 mm Complete Instrument 10 mm | | | |
|  | | KOCHER, Kavrayıcı Forseps, Atravmatik KOCHER, Grasping forceps, atraumatic | | | |
| | 28-132-000 | | 28-132-204 | | 28-132-208 |
| | 28-135-000 | | 28-135-204 | | 28-135-208 |
|  | | KOCHER, Kavrayıcı Forseps Atravmatik tek De Bakey KOCHER, Grasping forceps, atraumatic, single De Bakey | | | |
| | 28-147-000 | | 28-147-204 | | 28-147-208 |
| | 28-150-000 | | 28-150-204 | | 28-150-208 |
|  | | KOCHER, Kavrayıcı Forseps Atravmatik Çift De Bakey KOCHER, Grasping forceps, atraumatic, double De Bakey | | | |
| | 28-162-000 | | 28-162-204 | | 28-162-208 |
| | 28-165-000 | | 28-165-204 | | 28-165-208 |
|  | | Endo-Forceps, tek De Bakey ,yakın korumalı Endo-Forceps, single De Bakey with closing protection | | | |
| | 28-196-000 | | 28-196-204 | | 28-196-208 |
| | 28-197-000 | | 28-197-204 | | 28-197-208 |
|  | | Endo-Forceps, çift De Bakey yakın korumalı Endo-Forceps, double De Bakey with closing protection | | | |
| | 28-192-000 | | 28-192-204 | | 28-192-208 |
| | 28-193-000 | | 28-193-204 | | 28-193-208 |

Dış Boru
Outer tube

330 mm

28-000-200

10mm



Ayrıca tüm diğer kombinasyonların siparişi de alınmaktadır.
All further handle-combinations are also possible of course.

Endo-Kanca Sistemi Endo Hook System

Açık karın cerrahisinde en iyi sonuçları almak için geleneksel teknikleri geliştirdik. Modern video-endoskopik uygulama teknolojileri ve uygun araç-gereçlerle ameliyat erişim travmaları büyük ölçüde azalmış oldu. Küçük delikler ,karın kesitlerinin yerini aldı. Minimal yaygın cerrahinin avantajları ise sonuca gitmesindeki kolaylıklardır.

Endoser, yeni geliştirdiği bir dizi araç ilk laparoskopik çalışma tekniklerine çağdaş katkılar sunuyor.

Laparoskopik operasyonlar sırasında, situs operasyonlarının temiz bir şekilde hazırlanması için, Endoser size yüzlerce klasik karın cerrahisi örneği ışığında geliştirilen araçların ideal ve dengeli dizisini sunuyor.

Endoserin Yeni Endo-Kanca Sisteminde:

5 ve 10 mm çubuk şeklinde cihazlar ve bu cihazların düzeltilmiş ön-kanca ucu mevcuttur. Operasyon mekanizmalı yeni kol, size son derece değişken kademeli, 0 dan 90 dereceye kadar söz konusu kanca ayarlamasının yapılmasına olanak sağlar. Böylece, Endo-Kanca sistemi- miz klasik karın cerrahisi ile aynı başarıyı kanca ile yakalamanızı sağlamış olur

The good results of open abdominal surgery can hardly be improved upon using conventional techniques. Through the application of modern videoendoscopic technology and appropriate instruments, however, the trauma of operative access can be substantially reduced. Small punctures replace abdominal sections. The advantages of minimal invasive surgery are the result.

With a number of new developed instruments Endoser would like to make an up-to-date contribution to laparoscopic operating techniques.

For neat preparation of the operation situs during laparoscopic operations, Endoser now offers you the ideal balanced set of instruments developed in accordance with hundreds of tried and tested examples from classic abdominal surgery.

The new Endoser Endo Hook System
The Endo Hook System new developed by Endoser is a rod-shaped instrument having a diameter of 5 mm and 10 mm and on whose front end an Endo hook is fixed. At the top end of the instrument a handle with an operating mechanism is mounted, allowing for infinitely variable adjustment of the respective hook, from 0 to 90 degrees. Thus, with the help of an appropriate Endoser Endo hook, it is possible to achieve the same beneficial effects as with hooks used in classic abdominal surgery.

Monteli Araç



ASSEMBLED INSTRUMENT

Sökülmüş Araç



DISASSEMBLED INSTRUMENT

Alet uçlu giriş
Insert, with instrument tip









Handgriff
Handle

Vida kapaklı Dış boru
Outer tube with screw cap







Endo-Retraktörler, Ø 5/10 mm
Endo-Retractors, Ø 5/10mm

| | Çene Uzunluğu Jaw lengths | Ø | Çalışma Uzunluğu Working length | KOL Ø 5 mm Handle Ø 5 mm 28-000-059 | KOL Ø 10 mm Handle Ø 10 mm 28-000-060 |
|---|------------------------------|-------|------------------------------------|--|---|
| | | | 330 mm 430 mm |  |  |
| | | | Ürün Nr. Insert no. | Komple Cihaz Complete Instrument | |
|  | | | | Endo-Rekraktör ,Kocher-Langenbeck Endo-Retractor Kocher-Langenbeck | |
| | 30 mm | 5 mm | 29-001-000 | 29-001-159 | |
| | 40 mm | 5 mm | 29-002-000 | 29-002-159 | |
| | 50 mm | 5 mm | 29-003-000 | 29-003-159 | |
| | 30 mm | 10 mm | 29-011-000 | | 29-011-260 |
| | 40 mm | 10 mm | 29-012-000 | | 29-012-260 |
|  | | | | Endo-Retraktör, Cushing Endo-Retractor Cushing | |
| | 30 mm | 10 mm | 29-015-000 | | 29-015-260 |
| | 40 mm | 10 mm | 29-016-000 | | 29-016-260 |
|  | | | | Endo-Retraktör, Fan Şekil Endo-Retractor fan-shaped | |
| | 50 mm | 5 mm | 29-021-000 | 29-021-159 | |
| | 50 mm | 10 mm | 29-023-000 | | 29-023-260 |
|  | | | | Kavrayıcı Forseps, Kaba Desen Grasping forceps, heavy pattern | |
| | 35 mm | 5 mm | 29-030-000 | 29-030-159 | |
| | 35 mm | 10 mm | 29-031-000 | | 29-031-260 |
|  | | | | Özofagus retraktör, Grastik Bantlama İçin Esophageal Retractor, for grastic-banding | |
| | 35 mm | 10 mm | 29-032-000 | | 29-032-260 |
| | 35 mm | 10 mm | 29-033-000 | | 29-033-760 |

Dış Boru / Outer tube 330 mm 28-000-200 10 mm
Dış Boru / Outer tube 330 mm 28-000-100 5 mm
Dış Boru / Outer tube 430 mm 28-000-700 10 mm



Endo-Retraktörler Ø 10 mm
Endo-Retractors, Ø 10mm

| | Çene Uzunluğu Jaw lengths | Ø | Çalışma Uzunluğu Working length | Kol Ø 5 mm Handle Ø 5 mm 28-000-059 | Kol Ø 10 mm Handle Ø 10 mm 28-000-060 |
|---|------------------------------|-------|------------------------------------|--|---|
| | | | 330 mm |  |  |
| | | | Ürün Nr. Insert no. | Komple Cihaz Complete Instrument | |
|  | | | | Endo-Eksantrik „Y“ Retraktörü Endo-Eccentric „Y“ Retractor | |
| | 40-60 mm | 10 mm | 28-600-000 R | | 28-600-260 R |
| | | | | | |
|  | | | | Endo-Eksantrik „Y“ Retraktörü 2 Endo-Eccentric „Y“ Retractor | |
| | 60-40 mm | 10 mm | 28-600-000 L | | 28-600-260 L |
| | | | | | |
|  | | | | Endo-Eksantrik „Y“ Retraktörü 3 Endo-Eccentric „Y“ Retractor | |
| | 60-60 mm | 10 mm | 28-600-000 S | | 28-600-260 S |
| | | | | | |

Dış Boru
Outer tube

330 mm

28-000-200

10mm



Karaciğer Kaldırıcı
Liver elevator



29-02426

Leberelevator fächerförmig
Ø 10 mm

29-02426

Karaciğer Kaldırıcı Vantilatör Şekil
Ø 10 mm

Kırma uygulayıcı forsepsler ve Düğüm Kaydırma Araçları
Clip applying forceps and knot sliding instruments

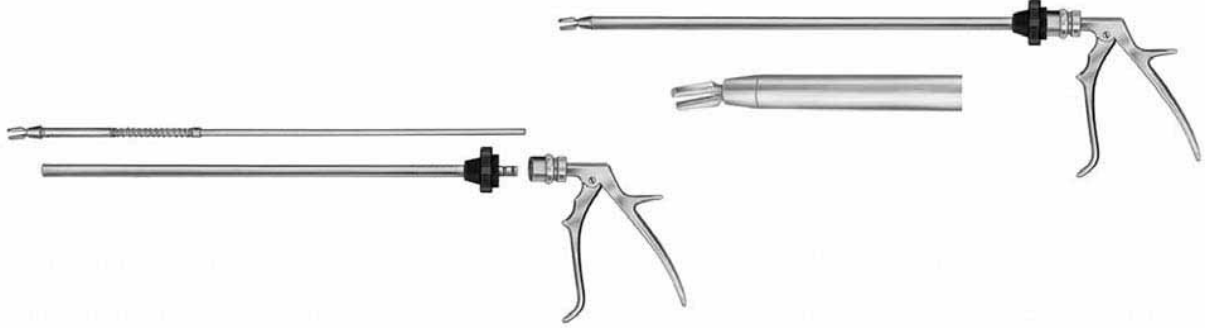

| | | | |
|------------|--|------------|--|
| 28-100-870 | Komple ETHICONTitan Kırma Seti:Ø 10 mm (Orta,geniş) İçerir: | 28-100-870 | Clip applying forceps Ø 10 mm for ETHICON TITAN LIGACLIP (medium-large) consisting of: |
| 28-100-000 | Giriş Forsepsi | 28-100-000 | Insert, forceps |
| 28-000-800 | Dış Boru Ø 10 mm | 28-000-800 | Outer tube Ø 10 mm |
| 28-000-070 | Handgriff | 28-000-070 | Handle |
| 28-100-850 | Kırma uygulayıcı forseps seti Ø 5 mm für ETHICON TITAN (Orta Boy) İçerir: | 28-100-850 | Clip applying forceps Ø 5 mm for ETHICON TITAN LIGACLIP (medium) consisting of: |
| 28-000-099 | Giriş Forsepsi | 28-000-099 | Insert, forceps |
| 28-000-801 | Dış Boru Ø 5 mm | 28-000-801 | Outer tube Ø 5 mm |
| 28-000-071 | Kol | 28-000-071 | Handle |



| | | | |
|----------|---------------------------------------|----------|--------------------------------------|
| 25-00500 | Aplikatör, Endo-Düğümleme için Ø 5 mm | 25-00500 | Applicator for Endo-ligature, Ø 5 mm |
|----------|---------------------------------------|----------|--------------------------------------|



| | | | |
|----------|-------------------------|----------|---------------------------------|
| 25-00501 | Düğüm kaydırıcı, Ø 5 mm | 25-00501 | Knot sliding instrument, Ø 5 mm |
|----------|-------------------------|----------|---------------------------------|



| | | | |
|----------|--|----------|--|
| 25-00502 | Düğüm Kaydırıcı Alet, Ø 5 mm Ekstra Korporel Düğümleme için (Sadece 25-00500 kod numaralı aplikatör ile çalışır) | 25-00502 | Knot sliding instrument for Extracorporeal knotting Ø 5 mm (only useable with applicator 25-00500) |
|----------|--|----------|--|



| | | | |
|----------|--|----------|--|
| 25-00503 | Düğüm Kaydırıcı Alet, Ø 5 mm Ekstra Korporel Düğümleme için (Sadece 25-00500 kod numaralı aplikatör ile çalışır) | 25-00503 | Knot sliding instrument for Extracorporeal knotting Ø 5 mm (only useable with applicator 25-00500) |
|----------|--|----------|--|

Temizlik ve Bakım
Care and Cleaning



24-00011

Temizleme Fırçası
500 mm uzunluk
Dış boru için
Ø 5 mm ve Ø 10 mm

24-00011

Cleaning brush,
500 mm length
for outer tubes
Ø 5 mm und Ø 10 mm



24-00010

Aletler için Yağ P 102, 50 ml

24-00010

Instrument oil P-102, 50 ml

Sökülebilir, Bipolar Pıhtılaştırma Forsepsleri Ø 5 mm x 340 mm
Detachable bipolar Coagulation Forceps Ø 5 mm x 340 mm

Monteli Araç

ASSEMBLED INSTRUMENT



Sökülmüş Araç

DISASSEMBLED INSTRUMENT



28-210-980

Bipolar,yalıtımlı yiv uçlu forseps seti:
İçerir,

28-210-980

Bipolar Forceps with
Fluted bit complete
consisting of:

28-210-000

Forseps

28-210-000

Insert forceps

28-000-920

Dış Boru Ø 5 mm

28-000-920

Outer tube Ø 5 mm

28-000-910

İç Boru

28-000-910

Inner tube

28-000-980

Kol

28-000-980

Handle



28-211-980

Bipolar Forseps, 3mm yivli set:

28-211-980

Bipolar Forceps with
3 mm bit complete
consisting of:

İçerir,

28-211-000

Forseps

28-211-000

Insert forceps

28-000-920

Dış Boru Ø 5 mm

28-000-920

Outer tube Ø 5 mm

28-000-910

İç Boru

28-000-910

Inner tube

28-000-980

Kol

28-000-980

Handle

Sökülebilir, Bipolar Pıhtılaştırma Forsepsleri Ø 5 mm x 340 mm
Detachable bipolar Coagulation Forceps Ø 5 mm x 340 mm

Monteli Araç

ASSEMBLED INSTRUMENT

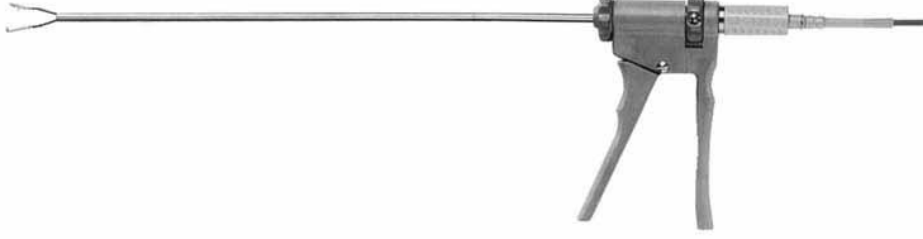

| | | | |
|------------|--|------------|--|
| 28-212-980 | Bipolar Forseps, Dalgalı Gövde, İçerir, | 28-212-980 | Bipolar Forceps with Rippled bar complete consisting of: |
| 28-212-000 | Giriş Forsepsi | 28-212-000 | Insert forceps |
| 28-000-920 | Dış Boru Ø 5 mm | 28-000-920 | Outer tube Ø 5 mm |
| 28-000-910 | İç Boru | 28-000-910 | Inner tube |
| 28-000-980 | Kol | 28-000-980 | Handle |



| | | | |
|------------|-------------------------------|------------|---|
| 28-213-981 | Bipolare Makas set İçerir, | 28-213-981 | Bipolar Scissors complete consisting of: |
| 28-213-000 | Forseps | 28-213-000 | Insert forceps |
| 28-000-920 | Dış Boru Ø 5 mm | 28-000-920 | Outer tube Ø 5 mm |
| 28-000-910 | İç Boru | 28-000-910 | Inner tube |
| 28-000-981 | Kol | 28-000-981 | Handle |

Sökülebilir, Bipolar Pıhtılaştırma Forsepsleri Ø 5 mm x 340 mm
Detachable bipolar Coagulation Forceps Ø 5 mm x 340 mm



| | | | |
|------------|--|------------|--|
| 28-209-980 | Bipolar Forseps Set Kleppinger Model içerir: | 28-209-980 | Bipolar Forceps Kleppinger complete consisting of: |
| 28-209-000 | Forseps | 28-209-000 | Insert forceps |
| 28-000-920 | Dış Boru Ø 5 mm | 28-000-920 | Outer tube Ø 5 mm |
| 28-000-910 | İç Boru | 28-000-910 | Inner tube |
| 28-000-980 | Kol | 28-000-980 | Handle |



| | | | |
|------------|--|------------|--|
| 28-208-980 | Bipolar Parçalayıcı Set MARYLAND Model içerir: | 28-208-980 | Bipolar Dissector MARYLAND complete consisting of: |
| 28-208-000 | Forseps | 28-208-000 | Insert forceps |
| 28-000-920 | Dış Boru Ø 5 mm | 28-000-920 | Outer tube Ø 5 mm |
| 28-000-910 | İç Boru | 28-000-910 | Inner tube |
| 28-000-980 | Kol | 28-000-980 | Handle |



| | | | |
|----------|---------|----------|---------|
| 28-00440 | Adaptör | 28-00440 | Adapter |
|----------|---------|----------|---------|



| | | | |
|----------|---------------|----------|----------------|
| 28-00400 | Valleylab-Fiş | 28-00400 | Valleylab-plug |
|----------|---------------|----------|----------------|



| | | | |
|----------|------------|----------|-------------|
| 28-00410 | Codman-Fiş | 28-00410 | Codman-plug |
|----------|------------|----------|-------------|



| | | | |
|----------|----------|----------|-----------|
| 28-00420 | Erbe-Fiş | 28-00420 | Erbe-plug |
|----------|----------|----------|-----------|



| | | | |
|----------|----------------------|----------|-----------------------|
| 28-00430 | Martin/Berchtold-Fiş | 28-00430 | Martin/Berchtold-plug |
|----------|----------------------|----------|-----------------------|